



GENUINE PARTS

INSTALLATION INSTRUCTIONS

1 DESCRIPTION:	Remote Engine Start
2 APPLICATION:	Q50 3.0L Engines Only
3 PART NUMBER(S) REQUIRED FOR INSTALLATION:	999K1 J4000 (Remote Engine Start Kit)
4 KIT CONTENTS:	

Item	Qty.	Part Description	Service Part Number
A	2	RES Key Fob	285E3 4HK0A
B	1	II Replacement Template	999V2 AW000
C	N/A	Installation Instructions	999K1 J4000II

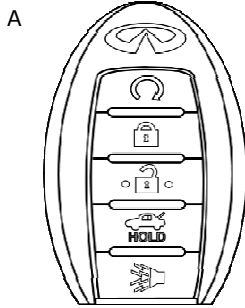

B  **Important: Read Before Installation!**
Dealer Installation Recommended.

⚠ WARNING

To avoid serious personal injury or property damage, obtain the Installation Instructions before attempting to install this accessory. The Installation Instructions provide the necessary procedures for a safe installation.

CUSTOMER INTERNET DOWNLOAD INSTRUCTIONS: Customers can obtain Installation Instructions for Infiniti or Nissan vehicles at www.Infiniti-TechInfo.com or www.Nissan-TechInfo.com respectively. From the home page, select Accessory Instructions. Select your Model, Model Year, and Accessory Type or search for your Model, and/or Model Year, and/or Accessory Type including Keyword or Part Number, then locate the Instructions for your accessory.

DEALER ASSIST DOWNLOAD INSTRUCTIONS: Dealership technicians can locate the Installation Instructions for this accessory by scrolling to and select "Acc. Install Instructions" tab. Always download and use latest version of the Installation Instructions.

Installation Instructions Replacement Template: 0999V2 AW000 Rev. 06/05/12

5 TOOLS REQUIRED:	<ul style="list-style-type: none"> CONSULT III plus Approved access to Immobilizer PIN
--------------------------	--

6 PRE-INSTALLATION CAUTION/NOTES:	<p style="text-align: center;">⚠ CAUTION</p> <ul style="list-style-type: none"> This is a ONE TIME ONLY programming procedure. Be sure to acquire ALL existing Non-RES key fobs from customer and new RES key fobs before proceeding. Please read these instructions carefully before beginning to ensure correct installation. Dealer Installation Only Specialty tools are required.
--	---

7 CRITICAL STEPS:	<p>The following steps are critical and must be performed as specified to ensure proper installation:</p> <ul style="list-style-type: none"> This accessory must only be installed as specified in these instructions. Do Not place key fob(s) on top of dashboard during programming. Frequency interference may occur. Be sure to avoid any other sources of frequency interference such as walkie-talkies, radios, etc. Be sure that vehicle is out of transit mode (shipping mode) by pushing in extended storage switch. Vehicle battery must be at or above 12.5 VDC.
--------------------------	--

INSTALLATION INSTRUCTIONS

8 Vehicle Preparation:

⚠ CAUTION

- Always confirm the ignition is in the "OFF" position before changing the E.S.S. position.

- 1) Apply parking brake
- 2) Confirm vehicle is no longer in default shipping state (Extended Storage Switch Pulled Up and BCM in Transit Mode). Failure to confirm vehicle has been removed from this state will result in loss of normal vehicle operation. Confirmation requires two checks:

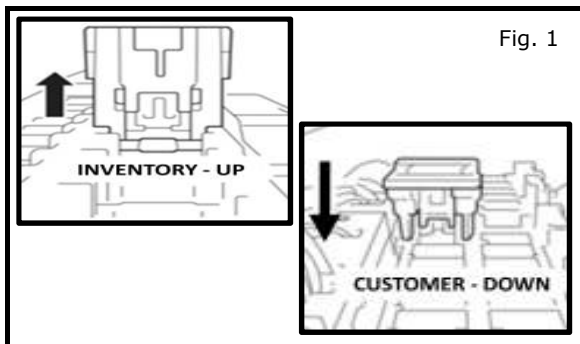

- 3) Locating Extended Storage Switch.
 - a) Locate Extended Storage Switch in cabin fuse block.
 - b) Check Extended Storage Switch is in "Customer" position as shown in Fig. 1.

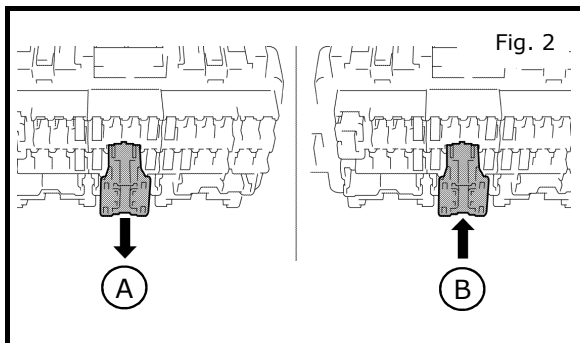

- 4) Engage and remove from transit mode
 - a) To engage transit mode, pull out in **A** direction as shown in the figure.
 - b) To remove from transit mode, press in **B** direction as shown in the figure.

Condition	Switch Position	Note
Vehicle is delivered to the dealer	Inventory Condition	
Technician performs PDI	Customer Delivery	Return to Inventory position after PDI.
Customer test drives the vehicle	Customer Delivery	Return to Inventory position after test drive.
Vehicle is being stored at the dealer	Inventory Condition	
Vehicle is delivered to customer	Customer Delivery	

- 5) Turn ignition switch to "ON" position
- 6) Record the customer radio presets and other presets as required.

Preset	1	2	3	4	5	6		

- 7) Put shift lever in "P" position for A/T and CVT or "1st" for M/T
- 8) Turn ignition switch to "OFF" position
- 9) Use seat and floor protection.

INSTALLATION INSTRUCTIONS

9 Vehicle Preparation:

- Locate OBD connector.
- Connect tool.
- Follow CONSULT III plus programming instructions.
- Verify RES operation.

10 Installation Procedure: Cautions / Notes

⚠ CAUTION

- Do not allow the Intelligent Key, which contains electrical components, to come into contact with water. This could severely affect system function. If the Intelligent Key gets wet, immediately wipe moisture from I-Key until completely dry.
- Do not drop the Intelligent Key.
- Do not strike the Intelligent Key sharply against another object.
- Do not change or modify the Intelligent Key.
- Do not place the Intelligent Key in an area where temperatures exceed 140°F (60°C) for any extended period of time.
- Do not attach the Intelligent Key with a key holder that contains a magnet.
- Take care not to scratch or damage any component during the installation process.
- Always follow the sequence of steps as they are shown, improper procedure can damage parts and/or systems.
- Be sure All key fobs for this vehicle have been acquired before proceeding.
- Avoid All other sources of frequency interference such as cell phones, walkie-talkies, radios, etc...
- DO NOT STOP or disconnect CONSULT III plus or VI until after the process has been completed.
- Dispose of old (original) key fobs once the RES installation process has been completed. DO NOT use fobs again and DO NOT return to customer.

11 Installation Overview

1.) SYSTEM

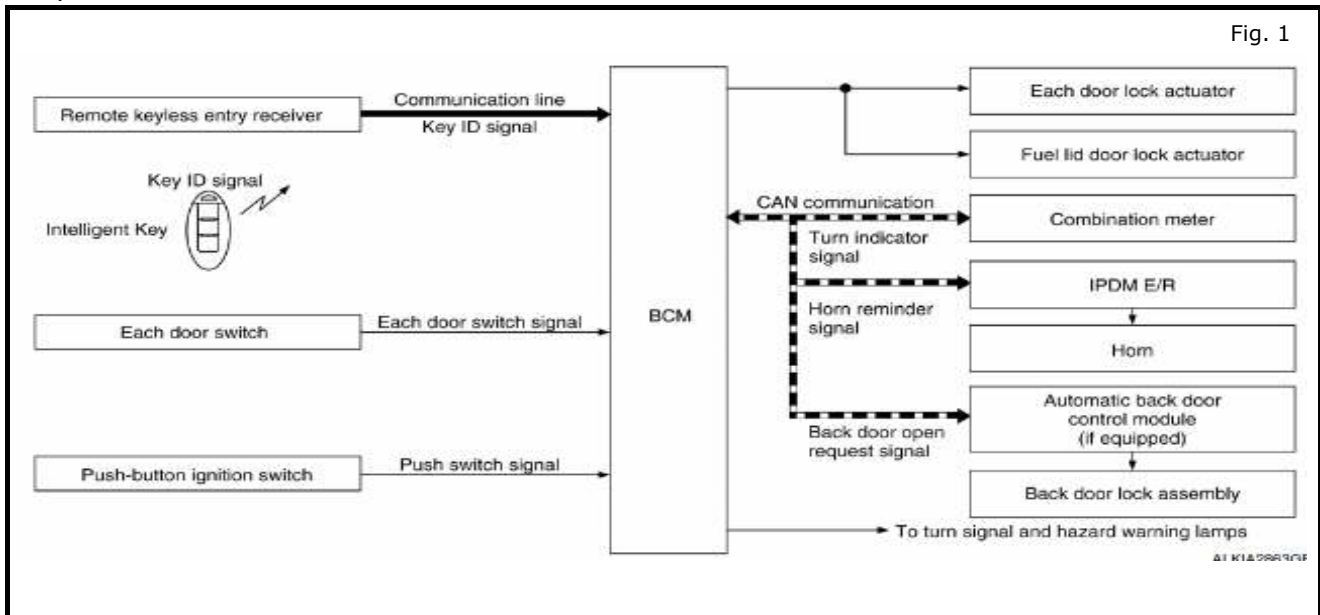

INSTALLATION INSTRUCTIONS

12 Installation Procedure: Vehicle Parts Installation

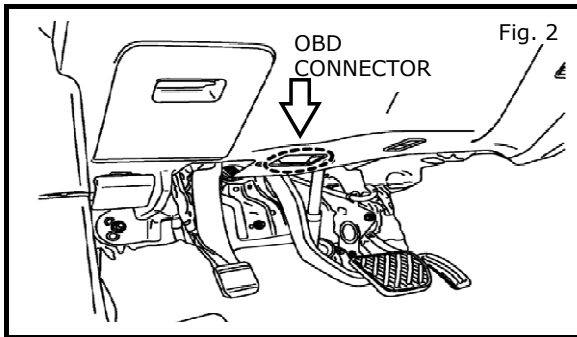

- 1) Locating the connector.
 - a) Locate OBD Connector under steering finisher as shown in Fig. 2.
 - b) Connect CONSULT tool to vehicle OBD connector as shown in Fig. 3.

⚠ CAUTION

- **Do Not** place key fob(s) on top of dashboard during programming. Frequency interference may occur.

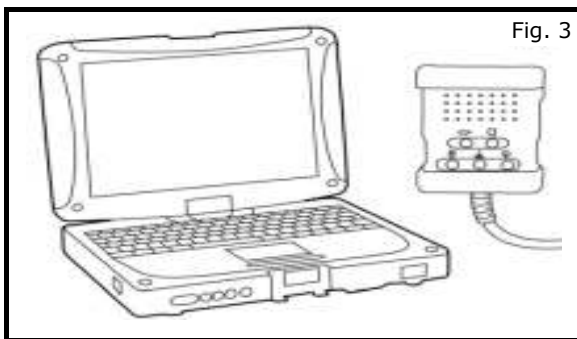

- 2) Connecting to the vehicle.
 - a) Press and hold Start Button for at least 2 seconds without depressing brake to put vehicle in Key On / Engine Off.
 - b) Turn on hazard switch to prevent BCM from entering into CAN communication sleep mode.

⚠ CAUTION

- **DO NOT STOP** or disconnect CONSULT tool or VI until after the process has been completed.

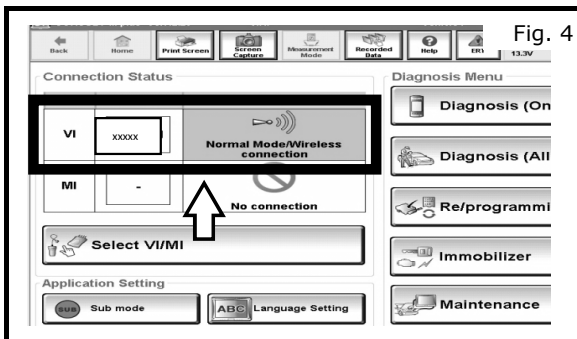

- 3) RES key fobs programming instructions.
 - a) Start CONSULT III plus make sure VI is connected. VI serial number will appear in VI section and the VI status will change to "Normal Mode" (green color) as shown in Fig. 4.
 - b) If VI is connected to vehicle go to step 8 and continue the installation. If VI is not connected to vehicle proceed to step 4.

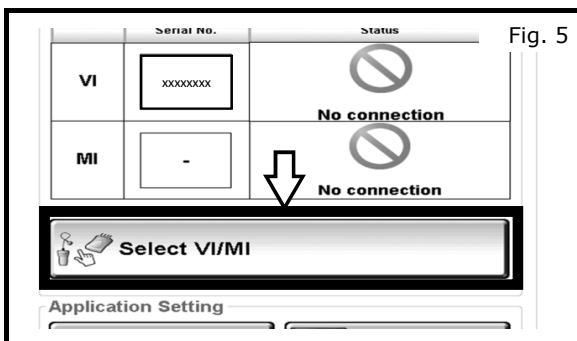

- 4) RES key fobs programming instructions.
 - a) If VI has not connected to vehicle click Select VI/MI button to connect with vehicle as shown in Fig. 5.

INSTALLATION INSTRUCTIONS

12 Installation Procedure: Vehicle Parts Installation

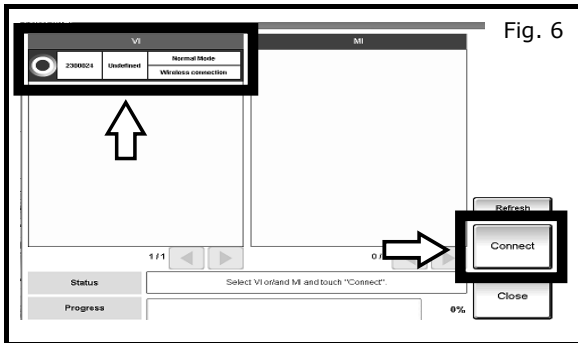

- 5) RES key fobs programming instructions.
 - a) Choose VI-2 detected as shown in Fig. 6.
 - b) Click "Connect" as shown in Fig. 6.

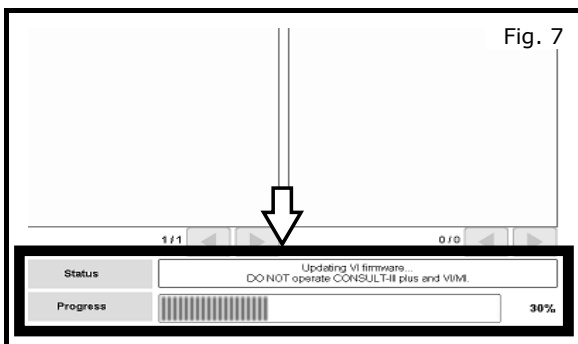

- 6) RES key fobs programming instructions.
 - a) Wait until update of VI-2 firmware is completed as shown in Fig. 7.

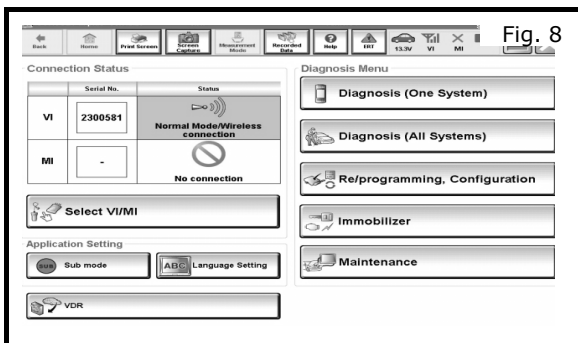

- 7) RES key fobs programming instructions.
 - a) CONSULT III plus will change to a home screen automatically when procedure is complete and VI-2 is connected on Bluetooth as shown in Fig. 8.
 - b) Proceed to step 8 and continue with installation.

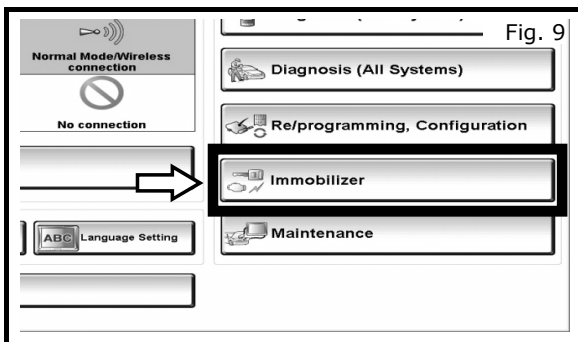

- 8) RES key fobs programming instructions.
 - a) Click "Immobilizer" as shown in Fig. 9.

INSTALLATION INSTRUCTIONS

12 Installation Procedure: Vehicle Parts Installation

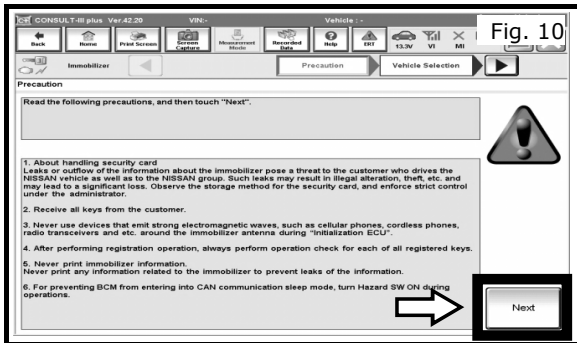

- 9) RES key fobs programming instructions.
 - a) A precaution screen will appear.
 - b) After you have finished reading all precautions, click "Next" as shown in Fig. 10.

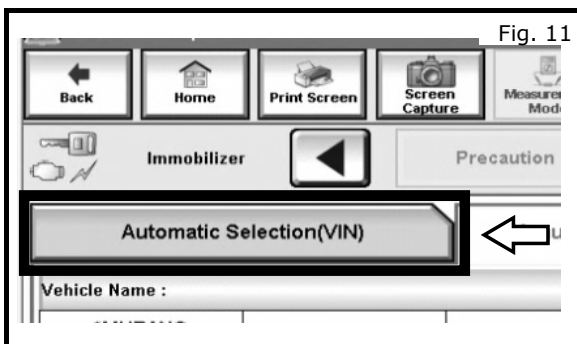

- 10) RES key fobs programming instructions.
 - a) Click "Automatic Selection" as shown in Fig. 11.

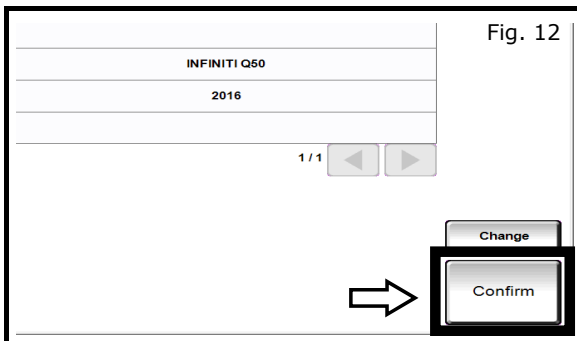

- 11) RES key fobs programming instructions.
 - a) Review information on confirmation screen, if correct press click "Confirm" as shown in Fig. 12.

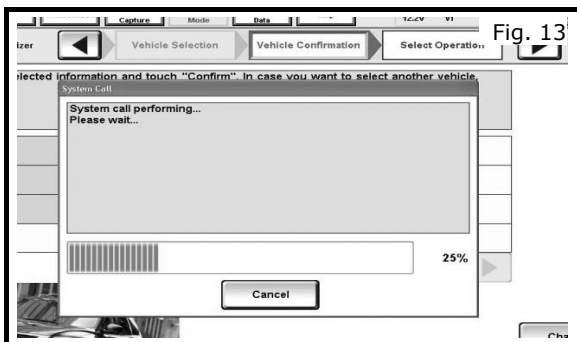

- 12) RES key fobs programming instructions.
 - a) Once you click "Confirm" you will see a system call menu as shown in Fig. 13.

INSTALLATION INSTRUCTIONS

12 Installation Procedure: Vehicle Parts Installation

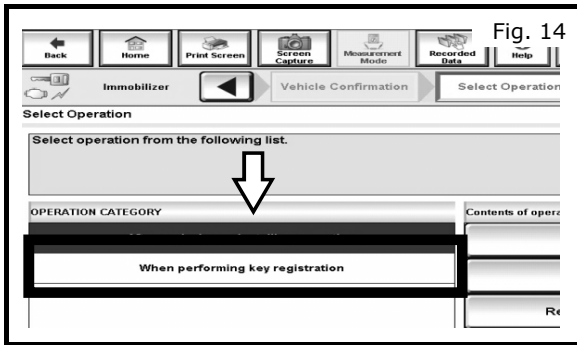

Fig. 14

- 13) RES key fobs programming instructions.
 - a) Once the system call is complete, you will enter the Select Operation screen will as shown in Fig. 14.
 - b) Under OPERATION CATEGORY menu click "When performing key registration" as shown in Fig. 14.

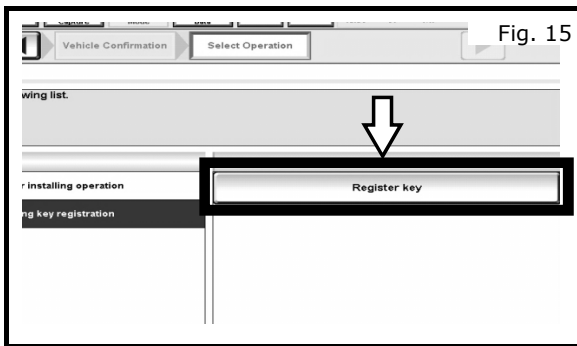

Fig. 15

- 14) RES key fobs programming instructions.
 - a) Once you click "When performing key registration" a new Contents of Operation selection "Register Key" will be available as shown in Fig. 15.
 - b) Under Contents of Operation selection click "Register Key" as shown in Fig. 15.

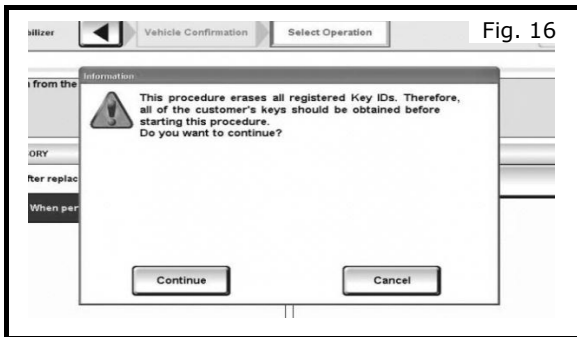

Fig. 16

- 15) RES key fobs programming instructions.
 - a) Follow the CONSULT III plus prompts as shown in Fig. 16

⚠ CAUTION

- **Do Not** proceed to Step 16 until the key registry process has been completed.

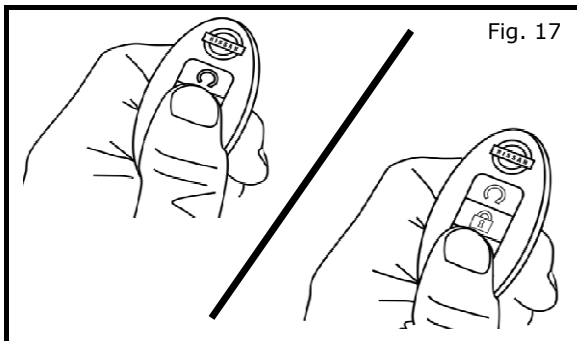
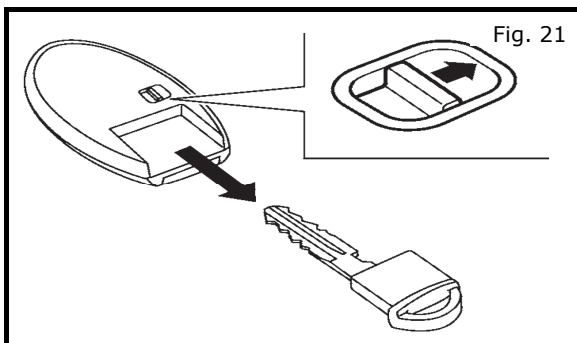
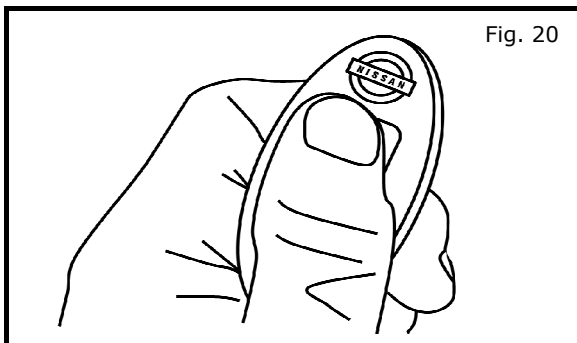
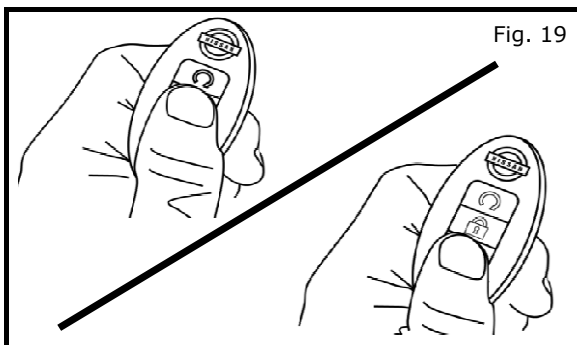
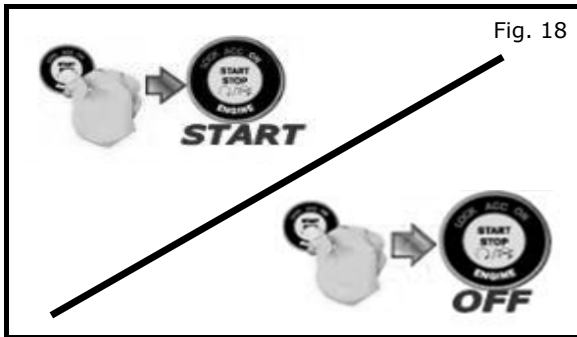

Fig. 17

- 16) New RES key fob confirmation.
 - a) From inside vehicle press Lock on Fob 1 and Unlock on Fob 2 and confirm that vehicle responds accordingly as shown Fig. 17.
 - b) From inside vehicle press Lock on Fob 2 and Unlock on Fob 1 and confirm that vehicle responds accordingly as shown Fig. 17.

INSTALLATION INSTRUCTIONS

12 Installation Procedure: Vehicle Parts Installation



- 17) New RES key fob confirmation.
 - a) Press and hold push button Ignition switch while depressing brake, to confirm vehicle starts as shown in Fig. 18.
 - b) Press push button Ignition switch and turn ignition switch to OFF position as shown in Fig. 18.

⚠ CAUTION

- **Remove all Key Fobs from the vehicle, before proceeding to the next step..**

- 18) New RES key fob confirmation.
 - a) From outside vehicle press Lock on Fob 1 and Unlock on Fob 2 and confirm that vehicle responds accordingly as shown Fig. 19.
 - b) From outside vehicle press Lock on Fob 2 and Unlock on Fob 1 and confirm that vehicle responds accordingly as shown Fig. 19.

- 19) New RES key fob confirmation.
 - a) Press and hold the RES button within five (5) seconds of pressing the LOCK button until the turn signal lights turn ON, then release to confirm vehicle starts as shown in Fig. 20.
 - b) Press and release RES button a second time to stop vehicle.
 - c) Lock vehicle and repeat sequence with second RES Key fob.

- 20) Disposing of original key fobs.
 - a) Before disposing of old fobs remove key by turning the fob over and sliding button to right as shown in Fig. 21.

INSTALLATION INSTRUCTIONS

12 Installation Procedure: Vehicle Parts Installation

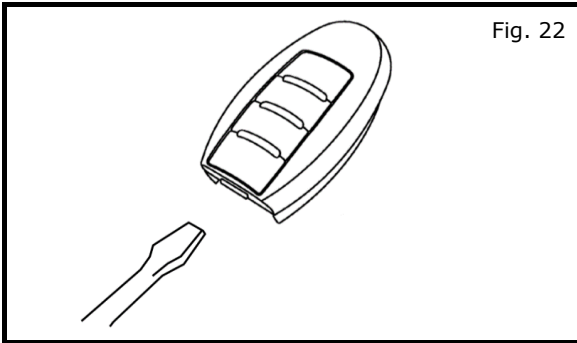

- 21) Disposing of old key fobs.
- Insert a small flat blade screw into bottom of old fob and gently pry apart as shown in Fig. 22.

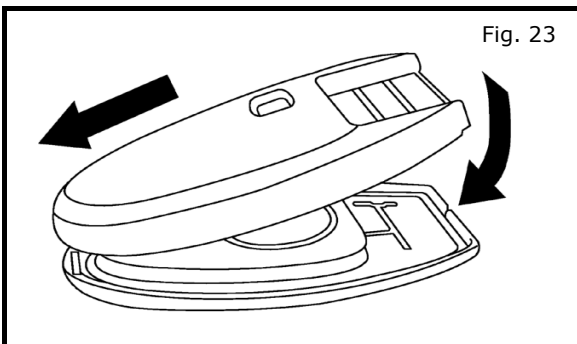

- 22) Disposing of old key fobs.
- Separate front and back halves as shown in Fig. 23.
 - Remove battery from back half of Key fob.

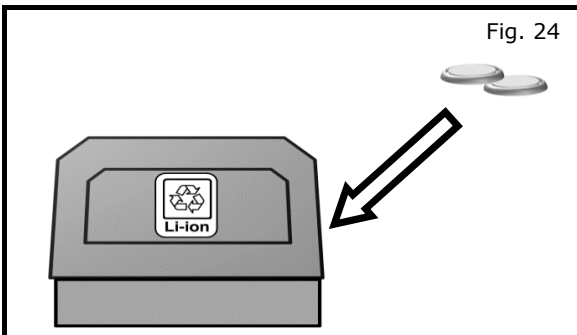

- 23) Disposing of old key fobs.
- Dispose of batteries appropriately as shown in Fig. 24.

CAUTION

- **Dispose of batteries in a proper recycling receptacle, not a trash can.**

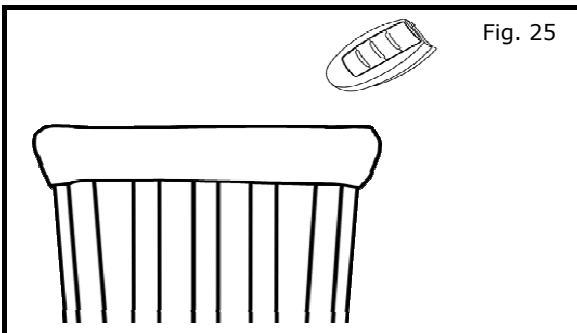

- 24) Disposing of old key fobs.
- Dispose of key fobs in a proper receptacle as shown in Fig. 25.

CAUTION

- **Be sure the batteries have been removed from All old key fobs before disposing of them.**

INSTALLATION INSTRUCTIONS

12 Installation Procedure: Vehicle Parts Installation

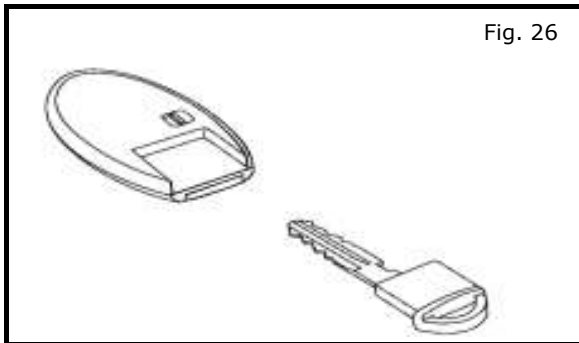

- 25) Disposing of old key fobs.
a) Insert keys into the new RES fobs as shown in Fig. 26.

INSTALLATION INSTRUCTIONS

13 Final Inspection:

CAUTION

- Refer to the vehicle service manual for more information.

- Verify interior and exterior is not damaged.
- Turn ignition switch to the "ON" position to confirm proper operation of vehicle systems.
 - That there are no new Diagnostic Trouble Codes.
 - Verify all windows and sunroof (if equipped), one touch operation and perform the reset procedure if necessary. Refer to the vehicle service manual for more details.
 - Tail Lamp - Turn on headlamps; open glove box and note whether light goes on.
 - Confirm proper audio function (AM, FM, SAT, CD and AUX).
 - Re-program radio presets and other vehicle settings to the recorded settings if necessary.
- Confirm RES function.
 - Turn IGN ON.
 - Turn IGN OFF.
 - Get out of the vehicle and close all doors (make sure the hood is closed).
 - Lock the vehicle with the remote.
 - Within 5 seconds, press and hold the RES button for more than 2 seconds.
 - Engine should start.
- Front Sonar Module Connector - Turn on vehicle, put vehicle in 'Drive'. Move slowly towards a large object in front of the vehicle. Note whether alarm sounds.
- Rear Sonar Module Connector - Turn on vehicle, put vehicle in 'Reverse'. Move slowly towards a large object behind the vehicle. Note whether alarm sounds.
- Place the Owner Manual, Quick Reference Guide, and/or other Manual in the glove box.
- If this vehicle will be returned to a dealer lot or showroom for an extended period of time, be sure the extended storage switch is placed in the "inventory" position.

INSTALLATION INSTRUCTIONS

14 Troubleshooting: Diagnosis

Operate RES, verify if the system is not working properly:

- a. Start the engine normally with the push-button ignition switch.
- b. Turn the ignition OFF, and then wait six (6) seconds.
- c. Exit the vehicle, make sure all doors are closed, and then lock the vehicle with the key fob.
- d. Within five (5) seconds of pressing the lock button, point the key fob at the vehicle, and then press and hold the RES button until the turn signal lights turn ON.
- e. At this time, the engine should start, the turn signal lights remain ON, and the doors should remain locked while the engine is running.
- f. If this condition does not occur, use the Supplemental Diagnosis Table below in addition to the ESM.

Supplemental Diagnosis Table

		Possible Cause	Confirmation of Cause	Resolution
The engine does not start using the RES feature (see steps a-e above)	1	ECM has not completed shutdown procedure after engine/ignition OFF.	ECM has to end shutdown process and save data prior to allowing RES to operate. Shutdown process takes 6 seconds to complete after engine/ignition is turned OFF.	Wait 6 seconds after engine has stopped prior to attempting RES activation.
	2	RES is correctly activated more than 2 times consecutively OR RES is activated once and with engine running another request is generated.	Not possible to confirm how many times RES has been activated.	Perform steps a-d above. This action will reset counter.
	3	One or more key fobs for this vehicle are still inside the vehicle.	With all known key fobs outside and out of range of vehicle, try to turn ON ignition with push-button ignition switch. If ignition turns ON, a key fob/I-Key remains inside vehicle.	Find and remove all remaining key fobs from the vehicle, lock doors with key fob, and then perform RES.
	4	Doors and trunk lid (or lift gate) are not closed and locked.	Doors/trunk lid/lift gate may not be completely closed and locked. Confirm both conditions in BCM Data Monitor: All doors closed - Status SW = ON All doors locked - Status = ON	Close and lock all doors/trunk lid/lift gate. If switches still do not show correct status, diagnose further with ESM.

INSTALLATION INSTRUCTIONS

14 Troubleshooting: Diagnosis

Supplemental Diagnosis Table (cont'd)

	Possible Cause	Confirmation of Cause	Resolution
The engine does not start using the RES feature	5	Door Lock button on key fob was not pressed prior to activating RES.	Not possible to confirm lock button was pressed first. Press the Lock button before pressing and holding the RES button.
	6	RES button on key fob is not held long enough.	Not possible to confirm how long RES button was held. Hold RES button for more than 2 sec to activate RES.
	7	Waited longer than 5 seconds to activate RES after door lock operation.	Not possible to confirm how long RES was pressed after lock. Press and hold RES button within 5 seconds of pressing lock button.
	8	Ignition switch is not in LOCKED position	Verify if ignition switch position (status) is in any status other than LOCKED. Change ignition switch to LOCKED status.
	9	The vehicle's shift selector is not in Park position.	Shift selector may look to be in Park but is not. Confirm in BCM Data Monitor: PN Switch = ON (with shift selector in Park) Verify shift selector is in Park position. If PN switch = OFF, diagnose further with ESM.
	10	Shift selector release button is not in released (unpressed) position.	Confirm in BCM Data Monitor: Detent SW = OFF (when release button is not pressed) If Detent SW = ON, diagnose further with ESM.
	11	Environmental factors block, reduce, or scramble signal strength from key fob to BCM.	RF interference may exist inside vehicle with aftermarket devices i.e. alarm systems OR other devices found near the key i.e. highway pass card OR RF device i.e. phone or portable garage door opener. Move vehicle from area where stationary source(s) of interference may be located and/or remove source(s) of interference away from the key fob or path of signal.
	12	Stop lamp switch is misadjusted or inoperative, giving a stop lamp switch ON signal (or brake pedal is applied).	Stop lamp switch adjustment may not be within specification. Confirm switch operation using ABS Data Monitor: Stop Lamp SW = OFF (with brake pedal released, not pressed) Adjust / Replace Stop lamp switch.

INSTALLATION INSTRUCTIONS

14 Troubleshooting: Diagnosis

Supplemental Diagnosis Table (cont'd)

		Possible Cause	Confirmation of Cause	Resolution
The engine does not start using the RES feature	13	Hood is opened.	Hood may not be completely closed. Confirm hood switch operation using IPDM Data Monitor: SW = ON (when hood is closed)	Check as needed: <ul style="list-style-type: none"> • Verify the hood is closed. • Confirm hood switch connection is secure. • Adjust / replace switch.
	14	Security system is currently activated (activation keeps engine from starting). Note: Horns may not be heard and lights may not be flashing.	Check Security system activation by trying to start engine normally (with push-button ignition switch). Note: Engine will not start with Security system activated.	Turn off/deactivate Security system (unlock doors with key fob). If condition persists, diagnose further using ESM.
	15	RES is attempted from within the vehicle.	RES can only operate from outside vehicle with doors locked.	Exit vehicle WITH key fob, lock doors and within 5 seconds activate RES.
	16	Specific DTCs may prevent RES from operating: B261B, B26FE, B26FD	Confirm with C-III plus no DTCs are stored.	Clear DTC(s) with C-III plus. If DTC(s) persist, perform further diagnosis using ESM.

INSTALLATION INSTRUCTIONS

15 Bill of Materials:

999K1 J4000 Remote Engine Start Kit

Item	Qty.	Part Description	Service Part Number
A	2	RES Key Fob	285E3 4HK0A
B	1	II Replacement Template	999V2 AW000
C	N/A	Installation Instructions	999K1 J4000II

INSTALLATION INSTRUCTIONS

16 Mechanization:

REMOTE ENGINE START FUNCTION : System Description

